

# LG CordZero™

## USER'S MANUAL

### A9

Make sure to read the "Safety Cautions" carefully before starting to use this product.

Please keep this User's Manual within easy reach of the user.

As the product is only intended for domestic use such as household cleaning, it must not be used for commercial, experimental or industrial purposes.

Make sure to fully charge the product's battery before first use of the product after purchasing it.



MFL69883617

[www.lg.com](http://www.lg.com)  
Copyright © 2018 - 2019 LG Electronics Inc. All Rights Reserved.



# TABLE OF CONTENTS

This User's Manual may contain images or contents that differ slightly to the purchased product.

<b>SAFETY CAUTIONS</b> .....	<b>04</b>
<b>PACKAGE INFORMATION</b> .....	<b>11</b>
<b>INSTALLATION</b> .....	<b>13</b>
Installing the floor standing charging station.....	13
Installing the wall-mount station .....	14
Uninstalling the station.....	14
Storage of the combination tool and crevice tool.....	15
Storage of the Mop Nozzle.....	15
Storage of the Mop Pads .....	15
<b>HOW TO USE</b> .....	<b>16</b>
Note about using the product.....	16
Using the Product .....	16
Charging the Product.....	17
Power / Suction Strength button.....	17
Using the nozzles .....	18
<b>MAINTENANCE</b> .....	<b>22</b>
Cleaning the Dustbin.....	22
Cleaning the Filters .....	22
Cleaning the Hard Floor Power Drive Nozzle®/ Multi-surface Power Drive Nozzle® .....	24
Cleaning the Bedding Power Punch .....	24
Cleaning of the Mop Nozzle.....	25
<b>POINTS TO CHECK BEFORE CONTACTING CUSTOMER SERVICE.</b> .....	<b>26</b>
<b>DISPOSAL INFORMATION</b> .....	<b>28</b>
Disposal of old products not related with the purchase of a new product.....	28
<b>PRODUCT SPECIFICATIONS</b> .....	<b>28</b>

## SAFETY PRECAUTIONS

The following cautions are intended to protect you from unexpected risk or property loss by ensuring safe and correct usage of the product.

Cautions are categorized into 'Warning' and 'Caution', which mean:



Pictograms are designed to draw attention to matters and uses that may pose a risk to the user. Make sure to carefully read any item marked with this symbol and comply with it to prevent any risk.



### **WARNING**

Failure to comply with this warning may result in serious damage, injury or even death to the user.



### **CAUTION**

Failure to comply with this warning may result in damage to the product or moderate injury to the user.

## **WARNING**

1. This appliance is not intended for use by persons (including children) with reduced physical, sensory or mental capabilities, or lack of experience and knowledge, unless they have been given supervision or instruction concerning use of the appliance by a person responsible for their safety.
2. Children should be supervised to ensure that they do not play with the appliance.
3. If the supply cord is damaged, it must be replaced by an LG Electronics Service Agent in order to avoid a potential hazard.
4. This appliance can be used by children aged 8 years and above and persons with reduced physical, sensory or mental capabilities or lack of experience and knowledge if they have been given supervision or instruction concerning use of the appliance in a safe way and understand the hazards involved. Children shall not play with the appliance.  
Cleaning and user maintenance must not be performed by children without supervision.

## Installation and Usage

**Do not install, charge or store the product where it may be exposed to water, rainfall or severe moisture. Do not use the product in any outdoor location, workshop or garage environment.**

- Such conditions will leave the product vulnerable to fire when charging the battery.
- Please install, charge or store the product in a well-ventilated place.

**Make sure to avoid places where there is a risk of leakage of flammable gas, industrial oil or metallic dust.**

- It may cause product malfunction or damage.

**If you intend to use the charging station by "standing" it vertically (standing type), make sure to secure it to the wall with the appropriate type of screws .**

- Otherwise, the charging station or product may slant and become damaged or cause property damage or injury.

**Please place the charging station on an even surface.**

- Otherwise, the product may fall and sustain damage or cause an injury.

**If you intend to mount the charging station on a wall (wall-mounted type), make sure to secure it tightly to the wall using the appropriate type of screws.**

- Failure to do so may damage the product and/or cause an injury.

**Please use the anchoring screws only when the wall is made of concrete or is solid enough.**

- If the Station mounting is performed on an unsuitable wall it may cause injury and damage the property or product.

**Never install the charging station on a wall with any piping (gas, water, air) or power cables or wires behind it.**

- There is a risk of injury from electric shock, fire or flooding.

**Do not use or store the product at temperatures below 5 ° C or above 38 ° C.**

- Failure to do so may damage the product.

## Power requirements

**This product should only be used with AC 230~240V. Make sure to check the power specifications of the place where you intend to use the product.**

- The wrong specifications will result in electric shock or damage the product in the event of a short-circuit.

**Do not apply excessive force to the power cord to bend it, or place it under a heavy object as this will damage it.**

- The power cord may get damaged and cause electric shock or injury.

**Please refrain from using multiple power appliances in one power board or power socket and make sure to use a power socket with a capacity of 10A.**

- Failure to do so may result in fire due to abnormal overheating of the socket.
- Or it may activate the circuit breaker leading to a loss of power.

**Never touch the power cord and plug with a wet hand.**

- This may result in injury or electric shock.

**Please clear any dust or water from the power cord and plug with a dry cloth.**

- Failure to do so may result in electric shock, short circuit or fire.

**When unplugging the power cord, never pull the cord itself and always hold the power plug.**

- Failure to do so will damage the cord it and may result in electric shock or fire.

**Stop using the product and contact the customer service department of LG Electronics if the power cord or power plug is damaged or the holes of the power outlet socket are loose.**

- Failure to do so may result in electric shock or fire.

**Make sure to unplug the power cord when cleaning or maintaining the charging station.**

- Failure to do so may result in injury or electric shock.

**Make sure to unplug the power cord when the product is not to be used for an extended period of time.**

- Failure to do so may result in electric shock, short circuit or fire.

**Make sure to organize the power cord of the Adaptor while using or cleaning the product.**

- Otherwise, the cord may get tangled with the product and result in malfunction, electric shock or injury if its disconnected or broken.

**Avoid touching the pins of the power plug with your finger(s) when unplugging the power cord.**

- Failure to do so may result in electric shock or fire.

**Do not to let children or pets get close to the product when using, charging or storing.**

- It may damage the product and/or result in injury.

**Do not hold the charging station upside down with the battery in the charging station.**

- Otherwise, it may damage the product and/or result in injury.

## **Proper usage**

**Make sure that no child is allowed to use the product.**

- The product is too heavy for a child to handle properly.

**Make sure that no hand, foot, hair or clothes gets stuck in the rotating brush or wheel while using or cleaning the product.**

- Failure to do so may damage the product or result in injury.

**No one other than a qualified technician/service engineer from LG Electronics may disassemble, repair or modify the product.**

- Do not attempt to disassemble or repair the product yourself as it may result in electric shock, injury or fire.

**Never use the battery, the charging station and the adaptor with other appliances other than this product.**

- It may cause a product malfunction or fire.

**Do not use the battery of another appliance in the product.**

- It may cause malfunctioning or fire.

**Do not arbitrarily disassemble, remove or short-circuit the battery.**

- It may result in electric shock, injury or fire.

**Do not apply heat or shock to the battery.**

- It may cause electric shock, injury or fire.

**Never insert a sharp metallic object such as a pin, nail or knife in a hole or gap in the product or the charging station.**

- Otherwise, you may get injured or suffer electric shock.

**Do not vacuum liquids with this product. Make sure that no water, beverage or detergent gets inside the product or the charging station.**

- Failure to do so may result in injury or electric shock.

**Do not apply or spray a flammable substance (gasoline or thinner) or surface active agent (detergent or bath soap) on the product.**

- It may result in malfunction or fire.

**In the event of a gas leakage (propane or urban gas), make sure to ventilate the area first without coming into contact with the product or its power plug.**

- Otherwise, there may be sparks which may result in an explosion, fire or injury.

**Do not let liquid stain the upper part of the mop nozzle. Do not clean a wet floor.**

- It may damage the product or cause electric shock.

**Do not use or store a heating device or flammable substance(ether, benzene, alcohol, chemicals, combustible spray, insecticide, air freshener or cosmetics) in close proximity to the product.**

- It may result in product malfunction or fire.

**Do not attempt to clean up a liquid substance (water, beverage), odorous substances (candy, chocolate, pet excrement, etc.), metallic objects (such as blade, pins), flammable substances, surface active agents, or glass shards with this product.**

- It may result in product malfunction or fire.
- In the event that any liquid, metallic object, glass shard or spark gets inside the product, immediately turn off the product and contact the customer service department of LG Electronics.

**Do not use the product with the exhaust or inlet port blocked.**

- It will cause the product to overheat and result in malfunction or fire.

**In the event that smoke is emitted by the product while it is charging, immediately unplug the power cord and contact the customer service department of LG Electronics.**

- Failure to do so may cause electric shock or fire.

**Do not expose the product, and the battery in particular, to heat, a heating device or direct sunlight.**

- It may result in electric shock, explosion or fire.

**Do not keep the product or its battery inside a vehicle which is exposed to direct sunlight.**

- It may cause fire or explosion.

**In the event that some kind of liquid leaks from the battery, make sure that it does not contact the skin or eyes.**

- It may burn the skin or severely damage the eyes.
- If liquid from the battery comes into contact with part of the skin, immediately wash it off with plenty of water and seek medical advice.

**Do not wash the inlet port with water or detergent.**

- As the inlet port contains a motor, it may result in electric shock or fire.

**Always use the charging station and adaptor provided with the product to charge the product and its battery.**

- Using any charging device other than the provided station and adaptor will damage the battery and result in electric shock, explosion or fire.

**Never allow any water, beverage or detergent to get inside the battery.**

- It may cause electric shock, explosion or fire.

**Do not touch the charging terminals on the product or the charging station, or insert an electrified object inside the product or the station.**

- Otherwise, you may get injured or suffer electric shock.

**Always leave the product on the floor standing or wall-mount charging station when it is not in use. Do not leave the product on the charging station not fixed to the wall or charging station support.**

- Otherwise, the product may fall and get damaged or cause injury.

**In the event that the earth leakage breaker gets activated while the product is placed on the charging station, immediately remove the product from the station and contact the customer service department of LG Electronics.**

- Failure to do so may cause electric shock or fire.

**Do not wash the dust bin with water.**

- The water will get into the motor and cause electric shock or fire.

**Do not attempt to vacuum fine dust such as cement with the product.**

- It may cause product malfunction or fire.

**Make sure that no child can play with the product, charging station or battery.**

- It may damage the product and cause an injury.
- If a child places the product or battery into its mouth, it will cause electric shock or injury, or damage the product or battery.

**When using the product, remove any wire or string from the bottom of the Charging Station.**

- Straps or wires may wrap around the product and cause a product malfunction or a broken cord.

**Do not insert your finger into the moving rotor.**

- It may cause an injury or product damage.

**Take caution not to get fingers caught in the flexible part of the nozzle.**

- Failure to do so may result in injury.

**Do not vacuum sharp objects (glass pieces, wire, blades, pins, etc.) with the mop nozzle attached.**

- It may cause injury or product damage.
- Particularly, a sharp object embedded in the mop, can cause injury when cleaning the mop pads after mopping.

**Mopped floors may become slippery until completely dry after using the mop function.**

**Please use caution if walking over mopped floors as they may be a slip hazard.**

- Failure to do so may result in injury.

## **Disposal**

**Discard the packing materials (plastic vinyl, styrofoam) properly so that no child comes into contact with them.**

- Such materials may cause a child to suffocate.

**When disposing of the product, make sure to remove the battery from the product's body.**

- Failure to do so may result in fire or explosion.



## CAUTION

### Proper usage

**Do not apply impact to the product or drop it from a height.**

- It may damage the product and/or result in injury.

**Make sure that the product does not fall.**

- It may cause injury or damage the product.

**Make sure that the filter is installed in the product prior to each use. Do not install wet or damp filters. They must be dry before fitting them.**

- Failure to install a filter may result in product malfunction.

**Make sure to wipe up any liquid such as water or oil or pet excrement from the floor before using the product.**

- Such substances will cause the unit to malfunction or cause irreparable damage

**Do not clean the product with a volatile or organic solvent (thinner or acetone).**

- It may damage the product.
- Always use a soft cloth to clean the product.

**Make sure to avoid running into a person or a pet while using the product.**

- It may cause injury.

**Do not kick or apply impact to the product.**

- It may cause the product to malfunction.

**Do not put any object other than the product, especially a metallic or magnetic object, on the charging station.**

- It may damage the product or cause electric shock.

**Do not clean the same spot repeatedly for an extended period of time.**

- Vibration from the inlet port or rotating brush may damage the floor or the carpet.

**Make sure that your finger does not get stuck when assembling the product or the charging station.**

- It may injure your finger.

**Do not let a child or a pet hang onto the charging station.**

- It may cause injury or damage the product.

**Do not put double-sided tape directly onto the wallpaper as it may be torn by external force.**

- Anchor the charging station with the wall anchoring screw(s) to prevent tearing of the wallpaper.

**Do not apply force or impact to the filter parts or dust bin parts.**

- The parts may become deformed, compromise the performance or cause the unit to malfunction.

**Do not remove the battery during operation.**

- It may cause the product to malfunction.

**If the motor is overheated by using the product for a long period of time, the product will automatically turn off by its built in safety device to prevent heat damage**

- After cooling for about 1 hour in a cool, well-ventilated area, turn on the power again.

**Do not leave the product standing on the charging station while the mop nozzle (and its water tank) attached to the main body.**

- The water may leak and damage the floor.

**Do not store the water tank where the temperature is 0 °C or lower.**

- It may result in product damage.

**Do not clean the same spot repeatedly for an extended period of time.**

- The water injection at the mop nozzle may cause the water get into the dust inlet and damage the main body.

**Do not use the mop nozzle for any purpose (e.g.: polishing a car, cleaning windows) other than domestic floor cleaning application**

- It may result in product damage.

**Do not trample on the mop nozzle.**

- It may result in product damage.

**Do not use the mop nozzle to vacuum liquid.**

- It may result in product damage.

**When using the mop nozzle, always attach the mop pads.**

- Failure to do so may cause damage to the floor or carpet.

**Do not clean the carpet with the mop nozzle.**

- The carpet may get wet or stick to the Velcro, causing damage to the carpet.

**Do not clean a coated floor.**

- If used repeatedly, the coating may peel off.

**Do not use the mopping functions on delicate floating floors.**

- Floors may absorb the moisture and become deformed.

# PACKAGE INFORMATION

## Standing type

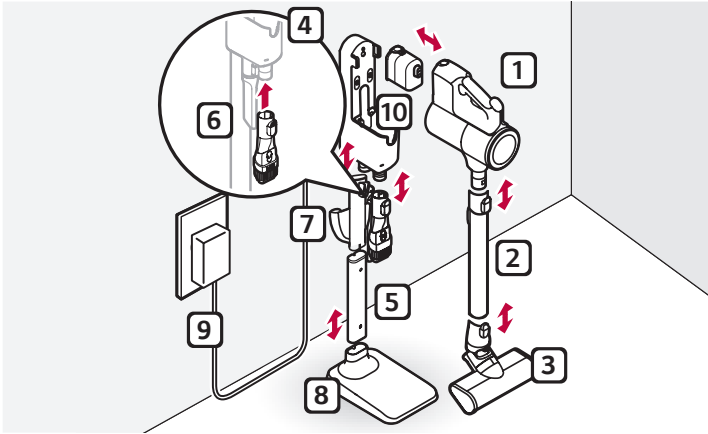

## Wall-mount type

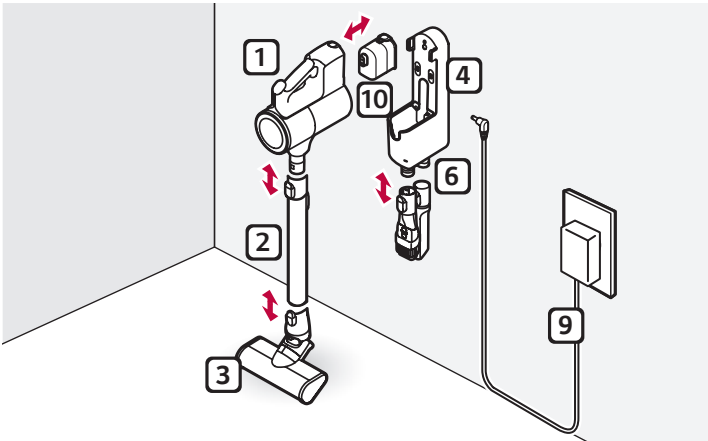

- |                                     |  |            |
|-------------------------------------|--|------------|
| 1 Product body                      | 5 Charging station pipe                    | 9 Adaptor  |
| 2 Extension pipe                    | 6 Combination tool and crevice tool holder | 10 Battery |
| 3 Multi-surface Power Drive Nozzle® | 7 Detachable stand for nozzle and mop pads |            |
| 4 Charging station                  | 8 Charging station support                 |            |

## Accessories

- Parts and accessories may vary depending on the model that you have purchased.

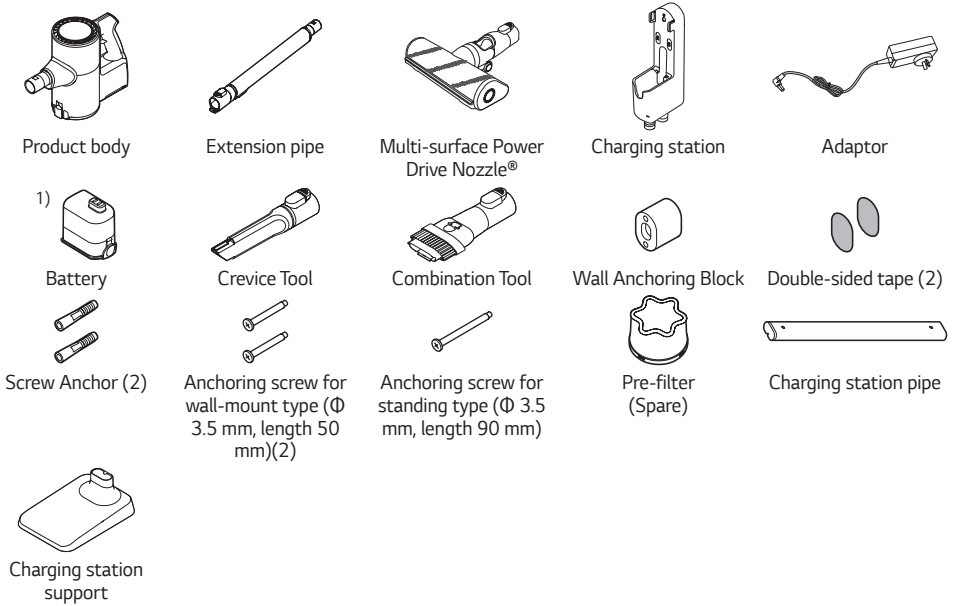

- Please note that these parts come with their corresponding models only.

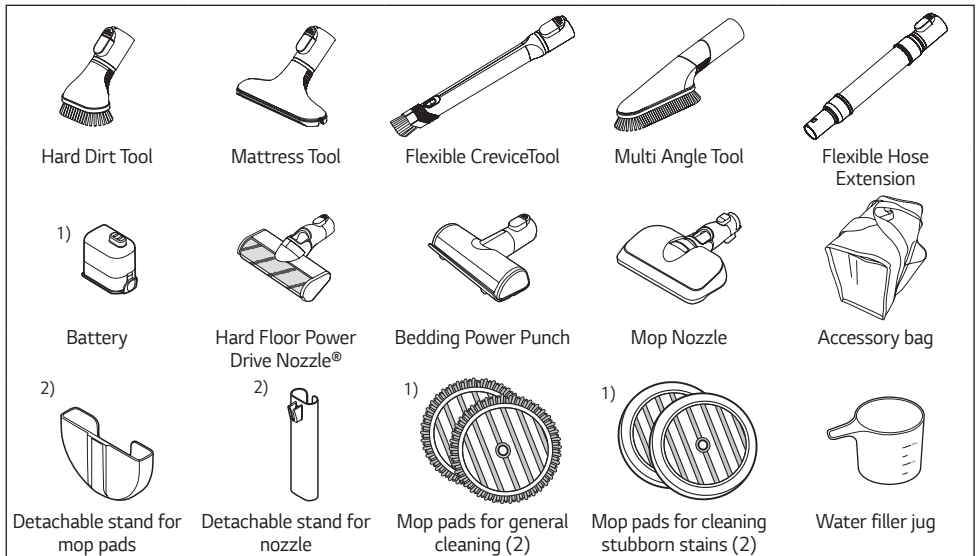

- 1) Mop pads, batteries and the pre-filter are consumables. You can buy them from an Authorised LG service or parts provider.  
 2) For some models, the Detachable stand for mop pads, mop nozzle and other nozzles are provided together in an assembled condition.

# INSTALLATION

## Installing the floor standing charging station

- 1 Place the charging station support on the floor and assemble the charging station pipe, the Detachable stand for nozzle and mop pads and the charging station in this order.

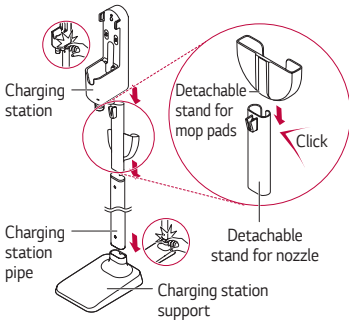

### ⚠ CAUTION

- Avoid getting your fingers stuck in any gap.
- 2 Connect the power adapter to the port on the back of the charging station and plug the power cord into the power outlet.
- The cord can be secured tidily by putting it through the power cord anchoring ring located on the back of the charging station pipe.

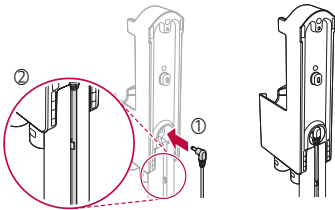

- 3 After ensuring there are no pipes or wires inside or behind the wall, make a hole at the appropriate height to anchor the charging station and insert the screw anchor.

- Recommended diameter of hole:  $\Phi 6.5$ ;
- Recommended depth: 100 mm.

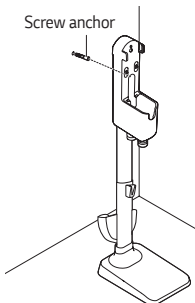

- 4 Put the anchoring block on the back of the charging station and anchor the charging station with the screw.
- Make sure to fully tighten the screw.

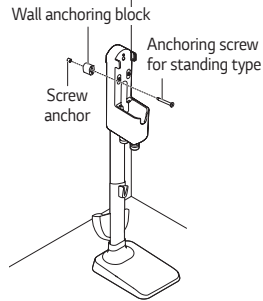

## When using double-sided tape (do not use if the wall is wallpapered)

- 1 Use double-sided tape to attach the wall anchoring block to the charging station in step 4.
- Be sure to remove the center part of the double-sided tape before mounting it.

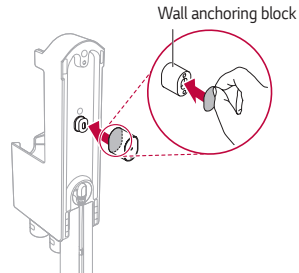

- 2 Use the remaining part of the tape to anchor the station to the wall before inserting the screw.

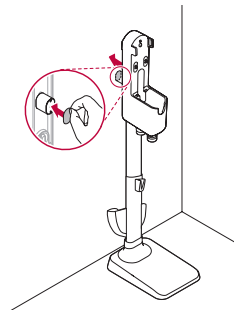

## ⚠ CAUTION

- Avoid dropping the product and parts when taking them out of the package. It may damage the product and/or cause personal injury.
- Do not use double-sided tape to anchor the charging station on papered walls. Please use the provided screws as otherwise the wall paper will get torn by movement of the charging station during the docking of the unit.
- We recommend anchoring the station with the anchoring screw.
- Use the anchoring screws only when the wall is made of concrete or is solid enough. An unsuitable wall can cause the mountings to weaken and cause the Charging station to fall causing injury and damage the property or product.
- Do not store the product or battery in the accessory bag except for the inlet ports and flexible hose extension.
- Be careful not to throw or drop the accessory bag carrying accessories such as the inlet ports. It may damage the product and/or cause personal injury.  
\* The accessory bag is provided only for an applicable model.

## Please note

- The charging station, its pipe and support cannot be disassembled separately once they have been assembled, and the charging station has been attached to the wall.
- If necessary, the charging station and the nozzle cradle can be separated from the charging station pipe. Pull the charging station upward and separate it in sequence while the charging station support is in a fixed state.

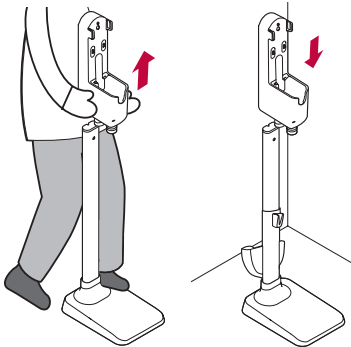

## Installing the wall-mount station

- 1 Connect the power adapter to the port on the back of the charging station and plug the power cord into the power outlet.
- 2 Ensure that there are no Electrical wires or water pipes inside the wall where the wall mount bracket will be attached to. By drilling or screwing, make a hole 1 meter from the floor to insert the wall plug or screw anchor.
  - Recommended diameter of hole:  $\Phi 6.5$ ;
  - Recommended depth: 60 mm.
- 3 Anchor the station to the wall with the provided anchoring screws.

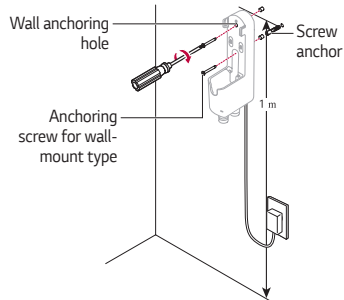

## Please note

- A service request to change the installation location of the charging station will incur additional costs if required to do so by a qualified installer.
- The Detachable stand for the nozzles and the Detachable stand for mop pads cannot be separated once they are assembled.

## Uninstalling the station

Keep and charge the product on the charging station after separating extension pipe and nozzle from the product body.

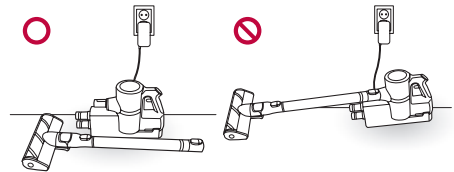

## ⚠ CAUTION

- Leaving the extension pipe and nozzle assembled for a long time may cause damage the product.

## Storage of the combination tool and crevice tool

Keep the combination tool and crevice tool on the charging station for easy access.

- 1 Attach the combination tool and crevice tool to the dedicated holders.

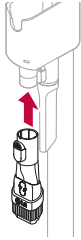

- 2 Press and hold the inlet removal button and pull downward to remove the combination tool or crevice tool.

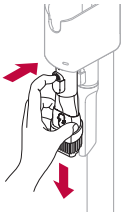

Nozzles provided additionally can be stored in the accessory bag.

\* The accessory bag is provided only for the applicable models sold with the Total Care Kit. Do not use the accessory bag for purposes other than for storage of nozzles.

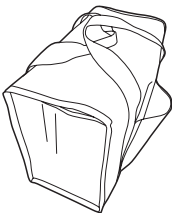

## Storage of the Mop Nozzle

Storing mop nozzles on the Detachable stand for nozzle and mop pads helps in finding and using the mop nozzle.

- 1 Mount the mop nozzle to the nozzle cradle.

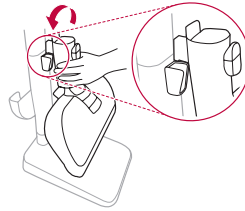

- 2 Lift the nozzle to separate the mop nozzle.

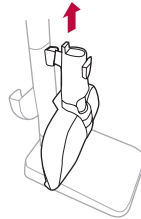

\* The Multi-surface Power Drive Nozzle® can be stored as well.

## Storage of the Mop Pads

Storing mops on the Detachable stand for mop pads helps in finding and using the mop. Up to 2 mop pads can be stored.

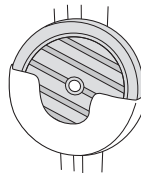

- After cleaning with a mop pad, wash and dry the mop pads before storage. A mop pad which has not been properly dried may emit an odour when stored.
- We recommend to hand-wash the mop pad with a pH-neutral detergent.
- Do not use bleach or fabric softener when washing the mop pad.
- It is not recommended to use a laundry dryer to dry the mop pad.
- Do not boil the mop pad. The mop pad may become deformed.

## Note about using the product

### Points to be aware of when using the product

- Make sure that the dustbin lid is on prior to using the product. Otherwise, the suction strength will deteriorate and cleaning will not be satisfactory.
- Support the bottom of the product when cleaning an elevated surface.
- When leaving the product unattended or unused for an extended period, make sure to place it properly on the charging station or lie it on the floor. Otherwise, the product may fall and get damaged or cause an injury.
- Make sure that the exhaust filter is properly assembled before using the product.
- Environmental conditions such as temperature and humidity may cause static to accumulate on the product. Please contact the customer service department of LG Electronics if the problem persists.
- Any foreign object on the inlet port or extension pipe will prevent the product from functioning properly. Make sure to remove any foreign object such as a sock or stocking before using the product.
- The battery runtime will be shortened after using the product repeatedly for an extended period due to its characteristics.
- When the battery is about to become fully run down during use, the last block on the battery indicator will start to flash and the product will power off after a while. Fully charge the battery in this case.
- Please use the product at normal room temperatures as the battery runtime will deteriorate severely if used at temperatures lower than 5°C or higher than 38°C for an extended period of time.
- Refer to Product specifications for battery run time details.
- These times are a guide only and may be less depending on the surface type.
- It is recommended to swap the battery on the main body and the battery on the auxiliary charging station regularly for maintaining the maximum life of the batteries. (For dual-battery models only)

## Using the Product

- 1 Assemble the body, extension pipe, inlet port, and battery in that order.

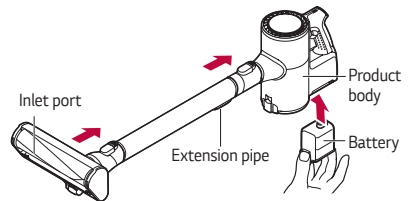

- 2 Press the button on the extension pipe to adjust its length.

- The pipe has 4 extendable length positions

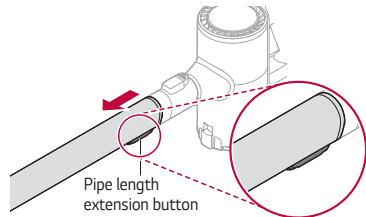

- 3 Attach the accessory tool to the body or the extension pipe.

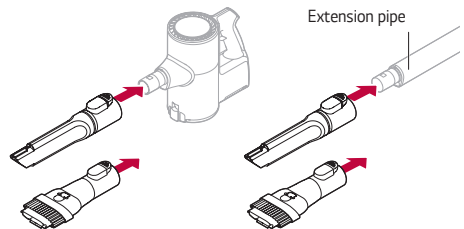

### ⚠ CAUTION

- Prolonged use of the product with the accessory tool attached may overheat the motor.
- Using the inlet port to clean a TV, monitor or LCD display may scratch the screen.
- Exercise caution to avoid getting your finger stuck in any gap when assembling the attachments.
- If any foreign object is sucked into the inlet during cleaning, operation of the vacuum cleaner might stop in order to prevent damage to the body or motor. Immediately stop using the vacuum cleaner and remove the object before resuming cleaning.



## Charging the Product

- 1 Put the product on the charging station.
  - The battery indicator will start to flash and charging will proceed in 3 steps.

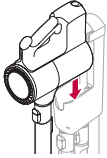

- 2 The battery indicator starts to flash and charging will start.
  - All of the indicators will stay on when the battery is fully charged.

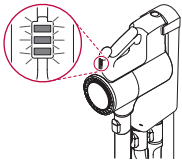

### ⚠ CAUTION

- Make sure to securely fit the unit on to the charging station. Otherwise, the product may fall and get damaged.

### Please note

- The battery will not be charged if the ambient temperature is below 5°C. Only charge the battery when ambient temperatures are between 5° and 38° C.
- The battery indicator will flash if the product is fully charged, removed from the station, and charged again soon. The flashing stops soon, and the indicator stays on.

## Charging the auxiliary battery

- 1 Hold the product and pull the battery by pressing both ends of the battery.

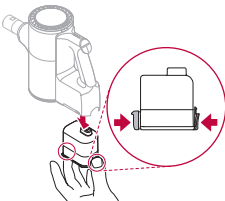

- 2 Insert the battery into the auxiliary charging station.

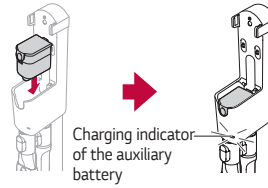

### Please note

- Make sure that the power adapter is connected to both the charging station and the power outlet
- If the main battery is charging on the charging station, the auxiliary battery will only start charging once the main battery is fully charged.
- The auxiliary battery indicator flashes when charging starts.
- The indicator will stay on when the auxiliary battery is fully charged.
- Fully charging a single battery usually takes 3.5 hours, but it will take twice as long if you charge it along with a discharged auxiliary battery.

## Power / Suction Strength button

You can adjust the suction strength with the suction strength button located on the handle.

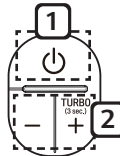

### 1 Power On/Off button

- Press the power On/Off button to activate the Normal mode.

### 2 Mode button

- Press "+" once to activate the Power mode.
- Press and hold "+" for more than 3 seconds to activate the Turbo mode.
- The unit will take a moment to switch to the Turbo mode from the Normal mode when the "+" button is held down.
- Press "-" to switch from Turbo to Power, or from Power to Normal.

## Using the nozzles

- Please note that the following applies to the corresponding models:
- The nozzle can be attached to the product body or extension pipe.
- Use a different mode if the inlet gets stuck on the floor, carpet or bed sheets or if you need a more powerful mode.

### CAUTION

- Do not use the product for any purpose other than domestic household.

### Multi-surface Power Drive Nozzle®

- It is suitable for cleaning carpets or rugs.
- It can be used to clean hard floors but will generate some noise.

### CAUTION

- Do not use this nozzle on a play mat (PVC) for children.

### Hard Floor Power Drive Nozzle® (some models only)

- It is suitable for cleaning hard floor surfaces.

### Bedding Power Punch (some models only)

- Bedding Power Punch lets you clean bed sheets and covers more effectively. This attachment can be used to remove Pet Hair from various surfaces without hair tangling.
- Make sure to adjust the suction level to an appropriate setting when you vacuum-clean a blanket with a thin outer fabric as the cleaner may attempt to suck the outer fabric.

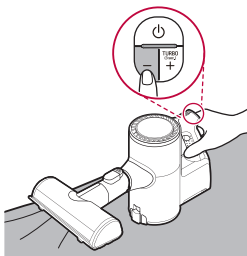

### Crevice Tool

It is suitable for cleaning dust in a corner or a narrow space.

### Combination Tool

This accessory is helpful for cleaning corners or small gaps.

#### Basic

For cleaning flat surfaces such as a sofa or mattress.

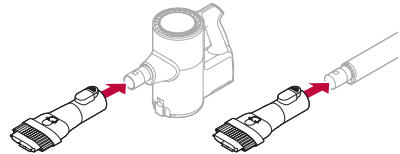

#### Brush type

For cleaning delicate surfaces such as a frame or furniture.

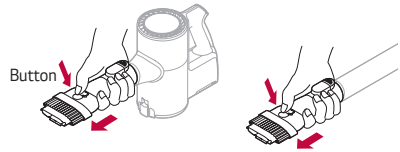

### CAUTION

- Prolonged use of the product with an accessory tool attached may over heat the motor.
- Using this accessory tool on a TV, monitor or LCD display may scratch the screen.
- Avoid getting your finger stuck in any gaps when fitting the accessory tools.
- If any foreign object is sucked into the inlet during cleaning, operation of the unit might stop in order to prevent damage to the body, motor or inlet. Immediately stop using the vacuum cleaner and remove the object before resuming cleaning.

## Hard Dirt Tool

It is firm bristles for removing dirt from hard surfaces.

## Mattress Tool

It is for mattresses and soft furnishing.

## Flexible Crevice Tool

Since its length can be adjusted and it can be bent, it is used for cleaning dust inside the vehicle or narrow spaces in furniture where bending is necessary.

### 1 How to operate the brush

- You can use the brush by holding and pulling the brush fixing unit in the arrow direction.
- You can insert the brush by pressing the button and inserting the brush fixing unit in the opposite direction of the arrow.

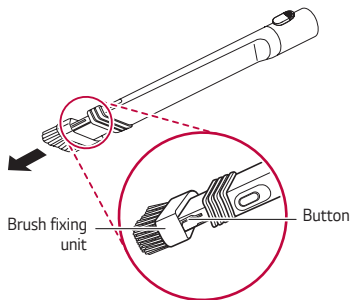

### 2 How to adjust the length

- Adjust its length by pressing the length extension button and pulling or pushing it to the end.

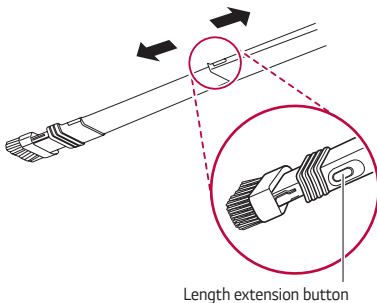

## Multi Angle Tool

Since it can be adjusted to various angles and the brush is soft, it is used to clean the console in the vehicle or on top of furniture.

## Flexible Hose Extension

Since its length can be adjusted, it is connected with the inlet port and used to clean out of reach places.

\* The flexible hose extension is provided only for an applicable model.

### Please note

- When the flexible hose extension is used, the Multi-surface Power Drive Nozzle®, Hard Floor Power Drive Nozzle® and the Bedding Power Punch do not work.
- Attach the Multi-surface Power Drive Nozzle®, Hard Floor Power Drive Nozzle® or the Bedding Power Punch to the body or the extension pipe when using it.

## Mop Nozzle

It is suitable for cleaning dust and mop cleaning at the same time.

### Please note

The mop pads will only rotate at one speed regardless of what power setting the Vacuum is set to.

### For mop cleaning

#### How to fill the water

- 1 Press the PUSH button to separate the mop nozzle and the water tank.

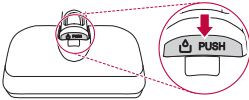

- 2 Open the cap on the side of the water tank.
  - Open one cap only. Opening both caps may cause the water to flush.

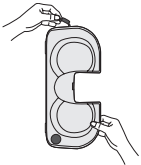

- 3 Fill the water to the MAX line and close the cap tightly. (Using the water filler jug will make the filling of water easier.)

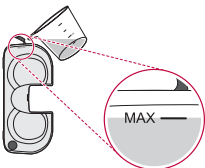

- If the water tank is filled with water and stored, water may slowly drip from the water tank and on to the air intake. When not using the mop nozzle, ensure that the water tank is empty empty.
- If you do not close the cap on the side of the water tank, water may leak.

Good)



Bad)

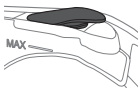

- 4 Assemble the mop nozzle and the water tank. Insert the 2 bumps in front of the tank and push until a clicking sound is heard.

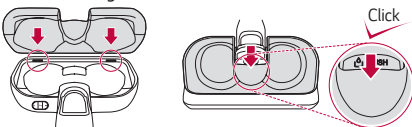

#### How to install the mop

- 1 Wet the mop pad with water before use.

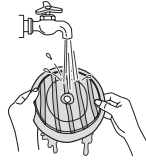

- 2 Squeeze the mop pad sufficiently to remove liquid.

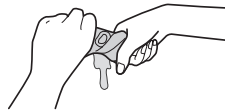

- 3 Align the center of the mop pad with the center of the mop attachment plate, and have the striped side of the mop face up.

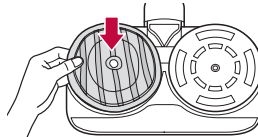

- Fitting the mop plate upside down or failure to attach the mop pad to the attachment plate properly may compromise the cleaning performance.
- Attaching the mop pad in a dry state may compromise the cleaning performance.

#### ※ How to install the mop pad properly

Good)

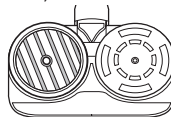

Bad)

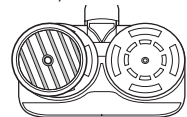

#### How to adjust the water flow to the Mop Pads

The amount of water injected from the mop nozzle can be adjusted.



Used to clean a moisture-sensitive floor or to supply a little amount of water



Used to clean ingrained dirt or to supply a large amount of water

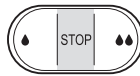

Used to stop the supply of water or clean with a dry mop

## For dry mop cleaning

- 1 Empty the water in the water tank.
- 2 Attach the dry mop pad to the mop attachment plate at the bottom of the mop nozzle.
- 3 Set the Water Adjustment button to STOP.

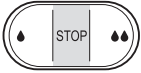

- 4 Turn on the power and begin mopping

### **⚠ WARNING**

- Do not insert your hand into the moving rotor. It may result in injury.
- Do not attach the mop pad while the mop nozzle is operating. It may result in injury.

### **⚠ CAUTION**

- Do not slam down or throw the mop nozzle onto the floor. Doing so may result in an injury or product damage.
- Do not let the product stand on the floor while the wet mop plates are attached. Doing so may result in damage or swelling to timber flooring.
- Set the Water Adjustment button to STOP when not using the product for an extended period of time. Otherwise it may result in a product failure.
- Do not use any other mop pad other than the one provided.
- Do not put liquid other than water in the water tank.
- Do not put hot water in the water tank.
- Do not step on the mop nozzle. It may result in product damage



- After cleaning, remove the remaining water in the mop nozzle with a tissue before storing. The water may leak and damage the floor.

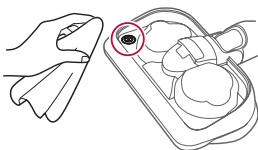

- Do not pull on the marked rubber. It may tear.

## Please note

- When using a mop, clean using straight lines and diagonal lines.

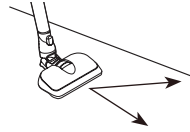

- Wet the mop and squeeze it sufficiently to remove any residual water before attaching the mop. Attaching and using a mop pad in a dry state may compromise the cleaning performance.
- When filling the water tank with water, do not fill the water more than the MAX line.
- Do not separate the cap of the water tank completely.
- Open only one cap of the water tank to fill the water.
- When cleaning is completed, always empty the water in the water tank. Otherwise the water may be contaminated and give off a bad smell. Shake the water tank to remove the remaining water.
- Open the 2 caps on the side of the water tank and dry for over 24 hours in a well-ventilated location with no direct sunlight.
- When cleaning with the mop is finished, separate and wash the mop pads. Otherwise the mop pads may give off a bad smell.
- Do not clean while a soiled mop pad is installed. Cleaning will not be effective.
- From now, the Water Adjustment button is set to Level 1. Press the button according to the amount of water needed.
- When moving around with the mop nozzle, set the Water Adjustment button to STOP.
- If there are foreign objects stuck in the mop attachment plate's rotating mechanism or a strong force or impact is applied to it, the mop attachment plate will stop automatically to protect the product. Press the Power button again to use the product because it is not a failure. Clean any foreign matter from the plate before turning it back on again.
- Use the mop pads for general cleaning or the mop pads for cleaning stubborn stains for their specific purpose to clean more effectively.

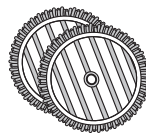

Mop pads for general cleaning



Mop pads for cleaning stubborn stains

## Cleaning the the Dustbin

- 1 Remove the battery from the unit before cleaning the dustbin.
- 2 Please empty the dustbin next to a wastebasket or where dust and foreign objects can be emptied easily.
- 3 Press the dustbin button downward to open it.
  - Empty the bin.
  - Be careful as dust/foreign matter may spill out when you open the dustbin.

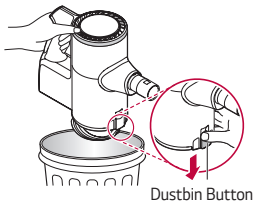

- 4 Insert the crevice tool into the large dust separation device (Cyclonic Mesh Filter) and turn it counterclockwise to remove it. Use the suction end of the crevice tool to do this with ease.

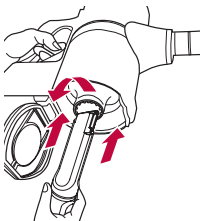

- 5 Wash the large dust separation device (Cyclonic Mesh Filter) with running water.
  - Be sure to dry the device completely before reinserting it.

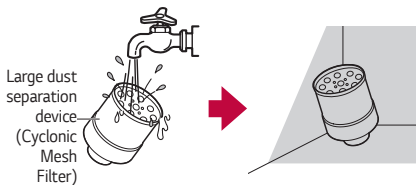

- 6 Remove the Cyclone and use the combination tool to clean out the dust inside the dustbin.

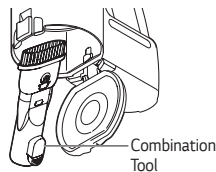

### ⚠ WARNING

- Never wash the product's body with water. Water may reach the motor and cause electric shock or fire.
- Do not apply force or any impact to the dust bin parts or the Cyclone as it may damage them.
- Use the product only after cleaning the Cyclone and reassembling it on the product. Failure to do so will damage the product.

## Cleaning the Filters

The pre-filter and exhaust filter need to be cleaned at least once a month to maintain the cleaning performance of the product. Clean these filters frequently when used in dusty environments and when the cleaner is used regularly.

- 1 Turn the exhaust filter counterclockwise to remove it and take out the pre-filter.

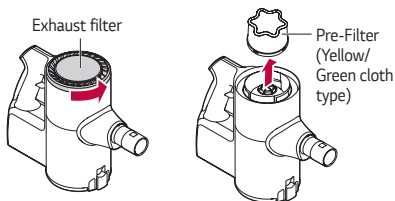

- 2 With the unit upside down, use the combination tool to clear dust from the motor part once the Dust separator filter has been removed.

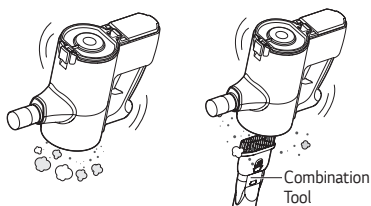

**3** Clean the exhaust filter by brushing the dust off or by washing it in running water.

- To maintain cleaning performance, remove the dust from the exhaust filter at least once a month.



- Wash the exhaust filter in running water if it emits an odor.
- The exhaust filter may emit an odor if it is not dried completely after it has been cleaned in water. Make sure to dry it completely for 24 hours in a well-ventilated area out of the direct sunlight before refitting it.

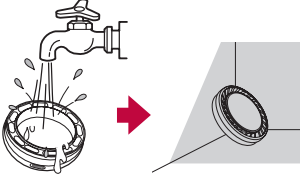

**4** Clean the pre-filter by brushing the dust off or by washing it in running water.

- When washing the cloth type pre-filter with water, it must be dried completely in a well-ventilated area out of direct sunlight before reinserting. Failing to do so will cause it to emit odours.
- As a spare pre-filter is provided for your convenience, two pre-filters can be used alternatively if necessary.
- The more often the filters are cleaned, the more optimal the suction power will be.
- Filters are consumables and will wear with time and use. Please purchase more filters from an authorized service center.

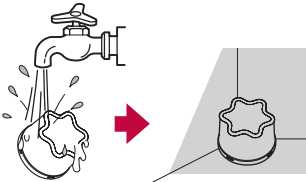

**5** To refit the filters, attach the pre-filter first, followed by the exhaust filter, so as to align the white circle near the battery level indicator and then turn it clockwise so that the white circles align with each other.

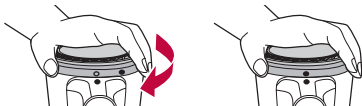

**⚠ WARNING**

- Never wash the product's body with water as it may reach the motor and result in electric shock or fire.
- Make sure that no foreign object reaches the motor as it will damage the product and may result in explosion or fire.
- Do not insert a finger or a sharp object near the motor as it will damage the product and may result in injury or electric shock.

**⚠ CAUTION**

- Make sure to reattach the exhaust filter and pre-filter to the product after washing them. Using the product without these filters will allow dust to reach the motor inside the product and cause malfunction.

**Please note**

- As too much dust will reduce the suction power, we recommend cleaning the filters before and after using the product.

**✘ Removing foreign objects from inside the product**

In order to maintain product performance, be sure to remove any foreign objects and dust from inside the product (body, pre-filter, extension pipe, inlet port). The foreign materials inside the product can cause the product to shutdown during operation, generate noise, or cause poor suction.

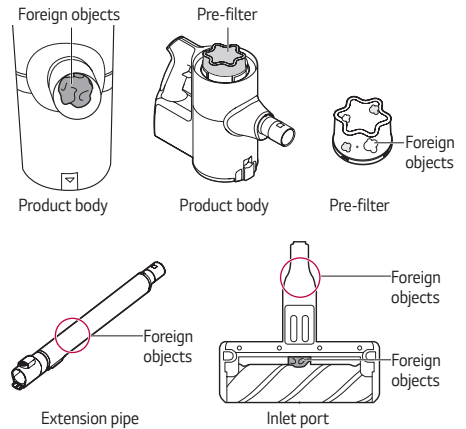

- ✘ If the inside of the product body, extension pipe, or inlet port or the pre-filter itself is clogged with foreign objects, the power automatically turns off to protect the product. Separate the battery from the product and remove the foreign objects.

## Cleaning the Hard Floor Power Drive Nozzle®/Multi-surface Power Drive Nozzle®

Please clean the Hard Floor Power Drive Nozzle® and Multi-surface Power Drive Nozzle® as follows:

- 1 Remove the nozzle from the product.
- 2 Turn the nozzle upside down and turn the rotating brush removal screw counterclockwise.
  - Use a flat head screwdriver to turn the screw.

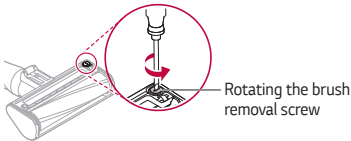

- 3 Pull the brush in the direction of the arrow to remove it.

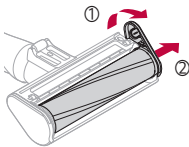

- 4 Attach the crevice tool to the unit and use the vacuum to remove dust/foreign objects from the brush and the bottom of the nozzle.

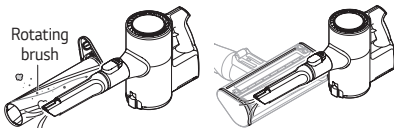

- 5 Use a wet towel or tissue to remove any remaining foreign matter and dust from the brush and the bottom of the nozzle.

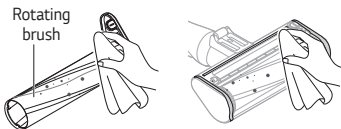

- 6 Assemble the brush in reverse order after cleaning.

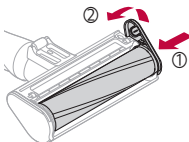

## ⚠ CAUTION

- Avoid getting your finger stuck in any gaps when reassembling.
- Do not wash the rotating brush and the nozzle with water.
- Do not use the rotating brush as a mop.
- Do not use the nozzle to absorb any liquid.

## Cleaning the Bedding Power Punch

- 1 Remove the Bedding Power Punch and turn it upside down.
- 2 Attach the crevice tool to the unit and use the vacuum to remove dust/foreign objects from the bottom of the Bedding Power Punch.

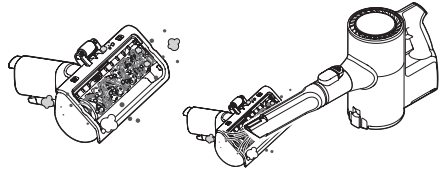

- 3 Use a wet towel or tissue to move any remaining foreign matter and dust.

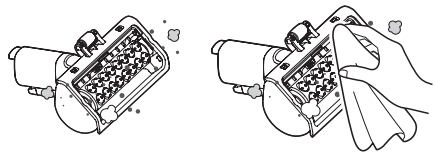

## ⚠ WARNING

- Do not wash the Bedding Power Punch with water.
- Do not suck any liquids including water into the Bedding Power Punch.



## Cleaning of the Mop Nozzle

Clean the mop nozzle as below.

- 1 Separate the nozzle from the product and turn the nozzle over.

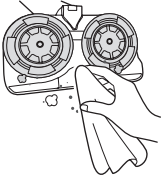

- 2 Attach the crevice tool to the main body of the vacuum to remove any foreign objects from its base.

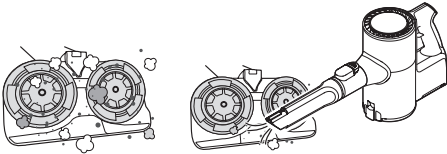

- 3 Remove the remaining foreign objects using a wet wipe or a tissue.

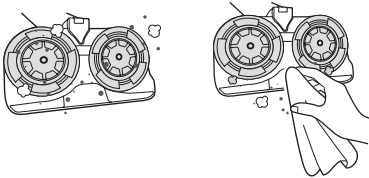

※ Foreign matter remaining on the nozzle may result in a bad smell.

### WARNING

- Make sure to separate the nozzle from the main body or separate the battery before cleaning. Otherwise the mop attachment plate may rotate and result in injury.

### CAUTION

- Do not clean or submerge the nozzle with water. It may result in product damage.

## Drying the water tank

Open the 2 caps on the side of the water tank and shake the water tank to remove the remaining water. Drying thoroughly for over 24 hours in a well-ventilated location with no direct sunlight is effective to remove moisture from the water tank.

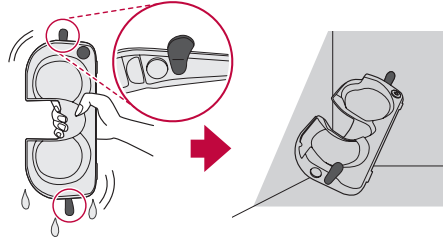

### Please note

- When cleaning is completed, always empty the water in the water tank. Otherwise the water may be contaminated and give off a bad smell.

### CAUTION

- Turn the direction of the cap to prevent the cap of the water tank from being closed.
- Do not separate the cap of the water tank completely.
- Do not add detergent, vinegar or baking soda to the water tank when washing.

## POINTS TO CHECK BEFORE CONTACTING CUSTOMER SERVICE.

Please check once again if one of the following symptoms is present while using the product. The product may not be malfunctioning.

Symptom	Cause	Solution
<b>The product does not operate.</b>	<b>Is the battery fully discharged?</b>	<ul style="list-style-type: none"> <li>Charge the battery.</li> </ul>
	<b>Is the product powered off?</b>	<ul style="list-style-type: none"> <li>Press the power button to power on the product.</li> </ul>
<b>Suction is too weak.</b>	<b>Is the dustbin full of dust?</b>	<ul style="list-style-type: none"> <li>Empty the dustbin.</li> </ul>
	<b>Is the filter clogged?</b>	<ul style="list-style-type: none"> <li>Clean the pre-filter and the exhaust filter.</li> </ul>
	<b>Is the inlet clogged?</b>	<ul style="list-style-type: none"> <li>Remove the extension pipe, remove any foreign objects from the product body.</li> </ul>
	<b>Is there a foreign object on the rotating brush of the inlet port?</b>	<ul style="list-style-type: none"> <li>Make sure to remove any foreign objects (thread, hair) from the rotating brush.</li> </ul>
<b>The unit does not appear to be charging.</b>	<b>Is the power adapter connected to the charging station?</b>	<ul style="list-style-type: none"> <li>Make sure that the adapter is properly plugged into the charging station.</li> </ul>
	<b>Is the power cord plugged into the outlet?</b>	<ul style="list-style-type: none"> <li>Make sure that the power cord is properly plugged into the power outlet.</li> </ul>
	<b>Is there any foreign object on the charging terminals?</b>	<ul style="list-style-type: none"> <li>Remove any foreign objects from the charging terminals with a dry cloth.</li> </ul>
<b>Hot air is expelled from the unit.</b>	<b>Is it operating properly?</b>	<ul style="list-style-type: none"> <li>The hot air originates from cooling of the motor and is not a sign of malfunction.</li> </ul>
<b>A strange odor is coming from the product.</b>	<b>Did you purchase the cleaner within the last 3 months?</b>	<ul style="list-style-type: none"> <li>The cleaner may emit a smell of rubber for about 3 months after purchase.</li> </ul>
	<b>Is it operating properly?</b>	<ul style="list-style-type: none"> <li>If the cleaner is working fine, it is not malfunctioning.</li> </ul>
	<b>Is the dustbin full of dust?</b>	<ul style="list-style-type: none"> <li>Also, dust in the bin may cause some odor. Empty the bin and clean it.</li> </ul>
	<b>Are there any foreign objects in the filter?</b>	<ul style="list-style-type: none"> <li>The filter may emit an odor if it has not been cleaned for some time. Clean both the pre-filter and the exhaust filter.</li> </ul>
	<b>Is the pre-filter wet?</b>	<ul style="list-style-type: none"> <li>Washing the pre-filter with water and not leaving it long enough to dry completely may cause it to smell. Make sure to dry it completely before reassembling it on the cleaner.</li> </ul>
	<b>Is the exhaust filter wet?</b>	<ul style="list-style-type: none"> <li>Washing the exhaust filter with water and not leaving it long enough to dry completely may cause it to smell. Make sure to dry it completely before reassembling it on the cleaner.</li> </ul>
	<b>Are there any foreign objects on the dust inlet of the mop nozzle?</b>	<ul style="list-style-type: none"> <li>Wet dust in the mop nozzle may result in odour. Make sure to wipe the dust inlet of the mop nozzle with a wet wipe before use.</li> </ul>

Symptom	Cause	Solution
The cleaner makes too much noise.	Is it operating properly?	<ul style="list-style-type: none"> <li>Different levels of noise is normal during operation due to three power settings. It is not a sign of malfunction.</li> </ul>
The unit powers off too soon or by itself after the motor speed fluctuates repeatedly.	Is the battery fully charged?	<ul style="list-style-type: none"> <li>The battery must be fully charged before cleaning. If the problem persists even though the battery is fully charged, and the pipes and attachments are clear from obstructions, then please contact LG customer service</li> </ul>
	Is there any foreign substance in the body of the product, extension pipe, or inlet port?	<ul style="list-style-type: none"> <li>Remove the foreign objects from the body of the product, extension pipe, or inlet port.</li> </ul>
	Is the filter clogged?	<ul style="list-style-type: none"> <li>Clean the pre-filter and the exhaust filter.</li> </ul>
The rotating brush does not rotate.	Is the brush properly attached?	<ul style="list-style-type: none"> <li>Remove the brush, clean it if necessary and attach it again.</li> </ul>
	Are there any foreign objects on the rotating brush?	<ul style="list-style-type: none"> <li>Remove any foreign objects from the rotating brush.</li> </ul>
The mop pad attachment plate does not rotate.	Did you press the mop nozzle hard?	<ul style="list-style-type: none"> <li>The mop attachment plate stops automatically to protect the product. This is not a failure. Press the power button again to use the product.</li> </ul>
	Are there any foreign objects between the mop attachment plate?	<ul style="list-style-type: none"> <li>Remove foreign objects from the mop nozzle attachment plate and press the power button again to use the product.</li> </ul>
There is no water coming out of the mop nozzle.	Is the water tank filled?	<ul style="list-style-type: none"> <li>In order for the water to come out of the mop nozzle, the water tank should be filled.</li> </ul>
	Is the water tank properly attached to the mop nozzle?	<ul style="list-style-type: none"> <li>In order for the water to come out of the mop nozzle, the water tank should be properly attached to the mop nozzle.</li> </ul>
	Is the Water Supply Adjustment button on?	<ul style="list-style-type: none"> <li>The water will not come out if the button is set to STOP.</li> <li>Press the Water Supply Adjustment button according to the type of cleaning.</li> </ul>
There is moisture in the water tank.	Have you thoroughly dried the water tank?	<ul style="list-style-type: none"> <li>The water tank will become moist if the water tank is containing water.</li> <li>Dry the water tank properly in a shadow.</li> </ul>
Using the mop nozzle makes the floor dirtier.	Did you clean the mop before use?	<ul style="list-style-type: none"> <li>Cleaning with a soiled mop may make the floor dirtier.</li> <li>Clean the mop before use.</li> </ul>

## DISPOSAL INFORMATION

### Disposal of old products not related with the purchase of a new product

You must contact your local city council or the related government authority before disposing of large appliances.

## PRODUCT SPECIFICATIONS

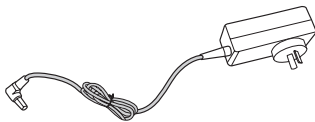
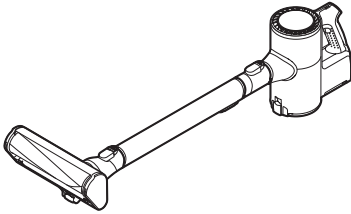

Item/Model	A9*****
Dimensions	260 mm(W) X 270 mm(L) X 1120 mm(H)
Weight	2.7 kg
Power consumption:	400 W (Maximum power: 450 W)/ 250 W/ 80 W (Turbo/Power/ Normal)
Suction power	140 W <sup>1)</sup>
Battery	DC 25.55 V
Battery runtime (When fully charged, and without using the Power Drive nozzles)	Approx. 6 minutes in Turbo
	Approx. 9 minutes in Power
	Approx. 40 minutes in Normal
Battery runtime (When fully charged, and using the Power Drive nozzles)	Approx. 6 minutes in Turbo
	Approx. 9 minutes in Power
	Approx. 30 minutes in Normal

Item	Charger (Adaptor)
Input	100 V - 240 V~ 50/60 Hz, 0.8 A
Output	DC 29.4 V 1.0 A

Item/Model	Battery
Type	Rechargeable Li-ion Battery
Rated	DC 25.55 V , 2000 mAh, 7 cells

1) Suction Power test based on IEC 62885-2, 5.8.

## Note

## Note



LG CordZero™